

## 74VHC132 Quad 2-Input NAND Schmitt Trigger

### General Description

The VHC132 is an advanced high speed CMOS 2-input NAND Schmitt Trigger Gate fabricated with silicon gate CMOS technology. It achieves the high-speed operation similar to Bipolar Schottky TTL while maintaining the CMOS low power dissipation. Pin configuration and function are the same as the VHC00 but the inputs have hysteresis between the positive-going and negative-going input thresholds, which are capable of transforming slowly changing input signals into sharply defined, jitter-free output signals. Thus greater noise margin than conventional gates is provided. An input protection circuit ensures that 0V to 7V can be applied to the input pins without regard to

the supply voltage. This device can be used to interface 5V to 3V systems and two supply systems such as battery backup. This circuit prevents device destruction due to mismatched supply and input voltages.

### Features

- High Speed:  $t_{PD} = 3.9$  ns (typ) at  $V_{CC} = 5$  V
- Power down protection is provided on all inputs
- Low power dissipation:  $I_{CC} = 2$   $\mu$ A (max) at  $T_A = 25^\circ$ C
- Low noise:  $V_{OLP} = 0.8$  V (max)
- Pin and function compatible with 74HC132

### Ordering Code:

Order Number	Package Number	Package Description
74VHC132M	M14A	14-Lead Small Outline Integrated Circuit (SOIC), JEDEC MS-120, 0.150 Narrow
74VHC132SJ	M14D	14-Lead Small Outline Package (SOP), EIAJ TYPE II, 5.3mm Wide
74VHC132MTC	MTC14	14-Lead Thin Shrink Small Outline Package (TSSOP), JEDEC MO-153, 4.4mm Wide
74VHC132N	N14A	14-Lead Plastic Dual-In-Line Package (PDIP), JEDEC MS-001, 0.300 Wide

Surface mount packages are also available on Tape and Reel. Specify by appending the suffix letter "X" to the ordering code.

### Connection Diagram

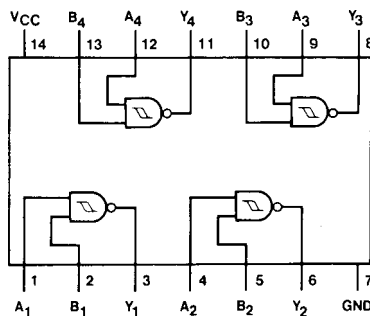

### Logic Diagram

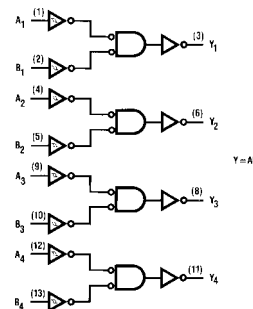

### Pin Descriptions

Pin Names	Description
$A_n, B_n$	Inputs
$Y_n$	Outputs

### Truth Table

A	B	Y
L	L	H
L	H	H
H	L	H
H	H	L

**Absolute Maximum Ratings** (Note 1)

Supply Voltage ( $V_{CC}$ )	-0.5V to +7.0V
DC Input Voltage ( $V_{IN}$ )	-0.5V to +7.0V
DC Output Voltage ( $V_{OUT}$ )	-0.5V to $V_{CC} + 0.5V$
Input Diode Current ( $I_{IK}$ )	-20 mA
Output Diode Current ( $I_{OK}$ )	$\pm 20$ mA
DC Output Current ( $I_{OUT}$ )	$\pm 25$ mA
DC $V_{CC}$ /GND Current ( $I_{CC}$ )	$\pm 50$ mA
Storage Temperature ( $T_{STG}$ )	-65°C to +150°C
Lead Temperature ( $T_L$ )	260°C
(Soldering, 10 seconds)	

**Recommended Operating Conditions** (Note 2)

Supply Voltage ( $V_{CC}$ )	2.0V to +5.5V
Input Voltage ( $V_{IN}$ )	0V to +5.5V
Output Voltage ( $V_{OUT}$ )	0V to $V_{CC}$
Operating Temperature ( $T_{OPR}$ )	-40°C to +85°C

**Note 1:** Absolute Maximum Ratings are values beyond which the device may be damaged or have its useful life impaired. The databook specifications should be met, without exception, to ensure that the system design is reliable over its power supply, temperature, and output/input loading variables. Fairchild does not recommend operation outside databook specifications.

**Note 2:** Unused inputs must be held HIGH or LOW. They may not float.

**DC Electrical Characteristics**

Symbol	Parameter	$V_{CC}$ (V)	$T_A = 25^\circ\text{C}$			$T_A = -40^\circ\text{C to } +85^\circ\text{C}$		Units	Conditions	
			Min	Typ	Max	Min	Max			
$V_P$	Positive Threshold Voltage	3.0			2.20		2.20	V		
		4.5			3.15		3.15			
		5.5			3.85		3.85			
$V_N$	Negative Threshold Voltage	3.0	0.90			0.90		V		
		4.5	1.35			1.35				
		5.5	1.65			1.65				
$V_H$	Hysteresis Output Voltage	3.0	0.30		1.20	0.30	1.20	V		
		4.5	0.40		1.40	0.40	1.40			
		5.5	0.50		1.60	0.50	1.60			
$V_{OH}$	HIGH Level Output Voltage	2.0	1.9	2.0		1.9		V	$V_{IN} = V_{IH}$ or $V_{IL}$	$I_{OH} = -50 \mu\text{A}$
		3.0	2.9	3.0		2.9				
		4.5	4.4	4.5		4.4				
		3.0	2.58			2.48				
4.5	3.94			3.80		$I_{OH} = -8 \text{ mA}$				
$V_{OL}$	LOW Level Output Voltage	2.0		0.0	0.1		0.1	V	$V_{IN} = V_{IH}$ or $V_{IL}$	$I_{OL} = 50 \mu\text{A}$
		3.0		0.0	0.1		0.1			
		4.5		0.0	0.1		0.1			
		3.0			0.36		0.44			
4.5			0.36		0.44	$I_{OL} = 8 \text{ mA}$				
$I_{IN}$	Input Leakage Current	0-5.5			$\pm 0.1$		$\pm 1.0$	$\mu\text{A}$	$V_{IN} = 5.5V$ or GND	
$I_{CC}$	Quiescent Supply Current	5.5			2.0		20.0	$\mu\text{A}$	$V_{IN} = V_{CC}$ or GND	

Noise Characteristics									
Symbol	Parameter	V <sub>CC</sub> (V)	T <sub>A</sub> = 25°C		Units	Conditions			
			Typ	Limit					
V <sub>OLP</sub> (Note 3)	Quiet Output Maximum Dynamic V <sub>OL</sub>	5.0	0.3	0.8	V	C <sub>L</sub> = 50 pF			
V <sub>OLV</sub> (Note 3)	Quiet Output Maximum Dynamic V <sub>OL</sub>	5.0	-0.3	-0.8	V	C <sub>L</sub> = 50 pF			
V <sub>IHD</sub> (Note 3)	Maximum HIGH Level Dynamic Input Voltage	5.0		3.5	V	C <sub>L</sub> = 50 pF			
V <sub>ILD</sub> (Note 3)	Maximum LOW Level Dynamic Input Voltage	5.0		1.5	V	C <sub>L</sub> = 50 pF			
<b>Note 3:</b> Parameter guaranteed by design									
AC Electrical Characteristics									
Symbol	Parameter	V <sub>CC</sub> (V)	T <sub>A</sub> = 25°C			T <sub>A</sub> = -40°C to +85°C		Units	Conditions
			Min	Typ	Max	Min	Max		
t <sub>PHL</sub>	Propagation Delay	3.3 ± 0.3		6.1	11.9	1.0	14.0	ns	C <sub>L</sub> = 15 pF
t <sub>PLH</sub>				8.0	15.4	1.0	17.5		C <sub>L</sub> = 50 pF
		5.0 ± 0.5		3.9	7.7	1.0	9.0	ns	C <sub>L</sub> = 15 pF
				5.9	9.7	1.0	11.0		C <sub>L</sub> = 50 pF
C <sub>IN</sub>	Input Capacitance			4	10		10	pF	V <sub>CC</sub> = Open
C <sub>PD</sub>	Power Dissipation Capacitance			16				pF	(Note 4)
<b>Note 4:</b> C <sub>PD</sub> is defined as the value of the internal equivalent capacitance which is calculated from the operating current consumption without load. Average operating current can be obtained from the equation: I <sub>CC</sub> (opr.) = C <sub>PD</sub> * V <sub>CC</sub> * I <sub>IN</sub> + I <sub>CC</sub> /4 (per gate)									

**Physical Dimensions** inches (millimeters) unless otherwise noted

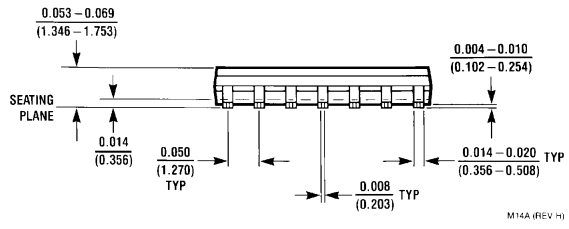
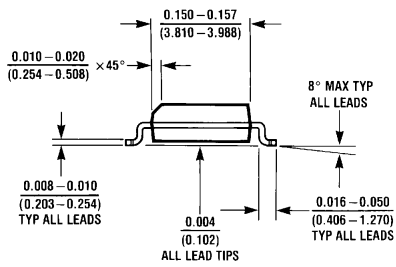
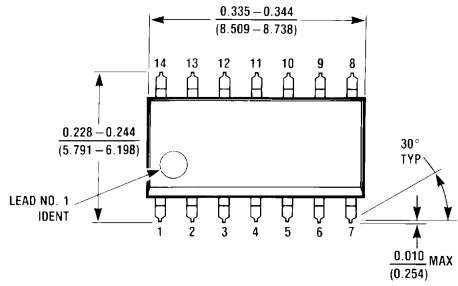

M14A (REV H)

**14-Lead Small Outline Integrated Circuit (SOIC), JEDEC MS-120, 0.150 Narrow Package Number M14A**

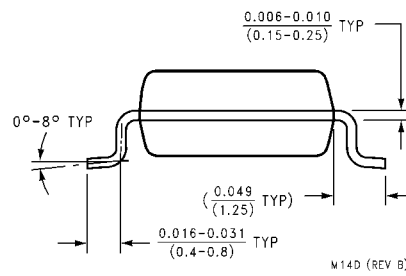
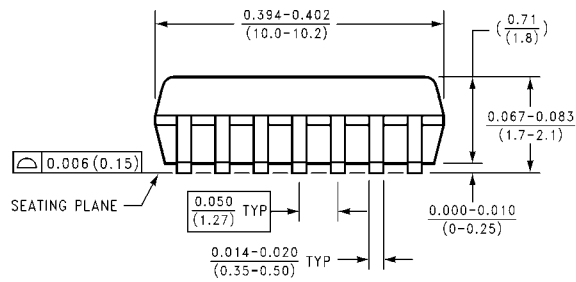
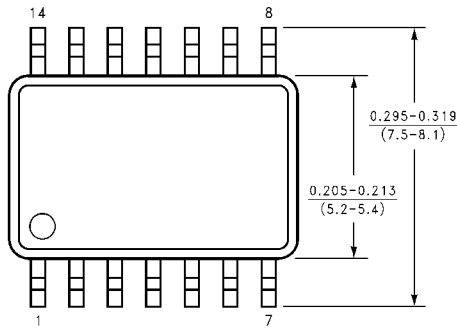

M14D (REV B)

**14-Lead Small Outline Package (SOP), EIAJ TYPE II, 5.3mm Wide Package Number M14D**

**Physical Dimensions** inches (millimeters) unless otherwise noted (Continued)

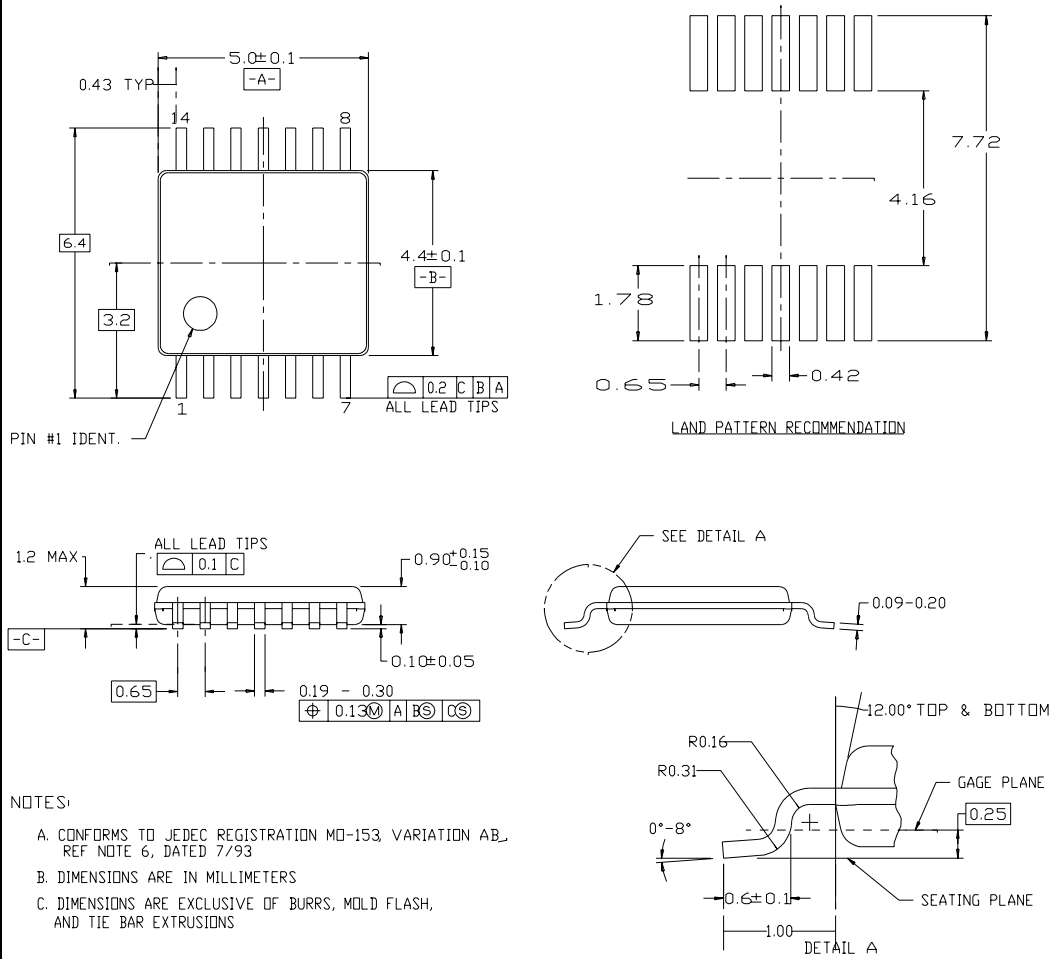

**14-Lead Thin Shrink Small Outline Package (TSSOP), JEDEC MO-153, 4.4mm Wide  
Package Number MTC14**

**Physical Dimensions** inches (millimeters) unless otherwise noted (Continued)



**LIFE SUPPORT POLICY**

FAIRCHILD'S PRODUCTS ARE NOT AUTHORIZED FOR USE AS CRITICAL COMPONENTS IN LIFE SUPPORT DEVICES OR SYSTEMS WITHOUT THE EXPRESS WRITTEN APPROVAL OF THE PRESIDENT OF FAIRCHILD SEMICONDUCTOR CORPORATION. As used herein:

1. Life support devices or systems are devices or systems which, (a) are intended for surgical implant into the body, or (b) support or sustain life, and (c) whose failure to perform when properly used in accordance with instructions for use provided in the labeling, can be reasonably expected to result in a significant injury to the user.
2. A critical component in any component of a life support device or system whose failure to perform can be reasonably expected to cause the failure of the life support device or system, or to affect its safety or effectiveness.

[www.fairchildsemi.com](http://www.fairchildsemi.com)